

EVALUATING INDIA'S CLIMATE TARGETS: THE IMPLICATIONS OF ECONOMY-WIDE AND SECTOR-SPECIFIC POLICIES

ARUN SINGH*

The World Bank, Washington, DC 20433, USA
arunsingh.2511@gmail.com

NIVEN WINCHESTER

Joint Program on the Science and Policy of Global Change
Massachusetts Institute of Technology, Cambridge, MA 02139, USA

Motu Economic and Public Policy Research
Wellington, New Zealand

VALERIE J. KARPLUS

Sloan School of Management
Massachusetts Institute of Technology, Cambridge, MA 02139, USA

Accepted 8 May 2019

Published 18 July 2019

We employ a numerical economy-wide model of India with energy sector detail to evaluate the impact of achieving India's commitments to the Paris Climate Agreement. We simulate targets for reducing CO₂ emissions intensity of GDP via an economy-wide CO₂ price and for increasing non-fossil electricity capacity via a Renewable Portfolio Standard. We find that compared with the no policy scenario in 2030, the average cost per unit of emissions reduced is lowest under a CO₂ pricing regime. A pure RPS costs more than 10 times the cost of a CO₂ pricing regime. Projected electricity demand in 2030 decreases by 8% under the CO₂ price, while introducing an RPS further suppresses electricity demand. Importantly, a reduction in the costs of wind and solar power induced by favorable policies may result in cost convergence across instruments, paving the way for more aggressive decarbonization policies in the future.

Keywords: India; Nationally Determined Contribution (NDC); climate change; paris agreement; renewable energy; carbon price; Renewable Portfolio Standards (RPS).

1. Introduction

India stands at a critical juncture in its development path. The country's current rate of economic growth (7%/year), among the fastest in the world, is projected to continue (World Bank, 2016, 2017). Over the past three decades, economic growth has

*Corresponding author.

This is an Open Access article published by World Scientific Publishing Company. It is distributed under the terms of the Creative Commons Attribution 4.0 (CC BY) License which permits use, distribution and reproduction in any medium, provided the original work is properly cited.

contributed to large increases in energy consumption, with the installed electricity capacity alone increasing by five times from 70 GW in 1992 to 350 GW in 2019 (CEA, 2019). However, while India accounts for 18% of the world's population, it uses only 6% of the world's primary energy (IEA, 2015), and its per capita electricity consumption in 2014 was a quarter of the global average (World Bank, 2014b). The industrial and household electricity consumption is, therefore, expected to continue rising sharply as India's economy grows in the coming decades. To meet the rising electricity demand, the installed capacity is expected to triple from 350 GW in 2019 to 1075 GW in 2040 (IEA, 2015).

At the same time, India's climate targets submitted in its Nationally Determined Contribution (NDC) to the 21st Conference of Parties in Paris (COP21) promise a reduction in CO₂ emissions intensity of GDP by 33–35% by 2030 from 2005 levels and an increase in non-fossil-based power to about 40% of cumulative installed capacity in 2030 (GoI, 2015).¹ Although the non-fossil electricity capacity target is included as an independent component in India's NDC, in practice, it will contribute to reducing the emissions intensity of the GDP. As emissions intensity targets apply to the entire economy while non-fossil electricity targets are sector-specific, they require separate instruments for implementation. An economy wide CO₂ price is, theoretically, the least cost instrument to achieve emissions reduction (Coase, 1960; Stavins, 2008; Metcalf and Weisbach, 2009), whereas Renewable Portfolio Standards (RPS) and Feed-in-tariffs are common regulatory instruments used to implement renewable targets. India's climate policy does not include an economy-wide CO₂ price,² but Renewable Purchase Obligations (RPO) — in principle similar to the RPS (in this paper, we use the two interchangeably) — are in place for states. Under the RPO, targets set in 2018 require that the electricity purchased by a distribution company in financial year 2022 (April 2021–March 2022) should include 21% renewable electricity (excluding hydropower), of which 10.5% should be from solar power. States in India have historically missed achieving their RPO, and the current targets are also considered ambitious, along with the recognition that renewable targets are not necessary to achieve India's emissions intensity targets as other measures may be more effective (Tongia, 2016). The very current question of which policies should be used to implement India's NDC motivates our inquiry, which involves comparing alternative approaches for meeting India's targets. Specifically, we evaluate the welfare implications of achieving India's CO₂ emissions intensity targets and assess the change in welfare implied by the addition of the non-fossil electricity capacity targets. To do this, we develop a model of the Indian economy and simulate India's emissions intensity targets through a CO₂ pricing policy implemented via an emissions quota

¹The non-fossil targets are conditional on receiving technology transfers and low cost international finance including from the Green Climate Fund (GCF).

²India levies a coal tax of Rs. 400 per metric ton (US\$ 6.27 per metric ton), with the revenues being recycled to states as a compensation for the recently implemented Goods and Services Tax (Economic Times, 2017).

indexed to GDP growth, with and without the non-fossil electricity targets imposed through an RPS.

If pricing carbon either through an emissions tax or a cap-and-trade scheme³ can equate the marginal cost of greenhouse gas (GHG) emission control with the marginal damages of climate externalities, the resulting level of emissions should be Pareto optimal. However, the implementation of a first-best optimal carbon price is hindered by multiple political economy constraints such as asset specificity (Murphy, 2002) and regulatory capture (Stigler, 1971) on the producer side and collective action (Olson, 1984) and principal agent problems (Eisenhardt, 1989) on the consumer side (Jenkins, 2014). The presence of such constraints leads to a second best scenario (Lipsey and Lancaster, 1956) in climate change mitigation, where a sub-optimal mix of policies, including market and regulatory measures, may keep ambitious emission targets within reach, but at the expense of economic efficiency (Bertram *et al.*, 2015; Jenkins and Karplus, 2016).

Morris *et al.* (2010) analyze the interaction of an RPS with a cap-and-trade scheme through a global computable general equilibrium (CGE) model (the MIT Economic Projection and Policy Analysis — EPPA — model) and find that adding an RPS to a cap-and-trade scheme increases the net present value welfare cost of meeting the emissions target while decreasing the CO₂ permit price to meet the target. The welfare cost increases due to higher electricity prices and lower demand, induced by a higher share of more expensive renewables in the mix, whereas CO₂ permit price decreases as mandated renewables achieve part of the emission reduction, bringing down the marginal cost that can achieve the remaining reduction. Using a multi-region, multiple-household CGE model of the US economy, Rausch and Karplus (2014) compare regulatory policies, such as an RPS, with a cap-and-trade scheme and demonstrate that regulatory policies result in substantially greater costs than a cap-and-trade system that achieves the same reductions in emissions at the national level.

Targeting emissions reduction through only a CO₂ pricing policy seems no more likely in India than elsewhere in the world, and indeed the policy approach in India's NDC does not mention CO₂ pricing. We are therefore interested in studying the impact of not just an economy-wide CO₂ pricing policy but also of an electricity sector-specific policy on India's economy, emissions, and electricity system. Using a newly developed multi-sectoral economic model of India with energy sector detail, we simulate an economy wide cap-and-trade scheme and an RPS to implement India's NDC against a reference case of no climate policies. We evaluate how consumer welfare, economy-wide and sectoral emissions, and electricity mix of India change under a carbon pricing regime, with and without an RPS for non-fossil electricity. Recognizing the rapidly declining costs of wind and solar power (IRENA, 2016), and

³Under certain assumptions, a carbon tax and a cap-and-trade scheme are expected to lead to similar outcomes (Weitzman, 1974; Aldy and Stavins, 2012). For the purpose of this work, we refer to both as carbon pricing policies.

India's policy support for their deployment, we also evaluate how policy-induced declines in the costs of wind and solar power can aid India's NDC implementation.

Prior work on analysis of India's climate trajectories involves application of both global and regional models. Fisher-Vanden *et al.* (1997) use a set of 14 multi-sector regional CGE models to determine comparative costs of stabilizing GHG emissions through two alternative policy instruments — carbon tax and global tradable permits — and find that a global tradable permits system with grandfathered emission allocation (based on 1990 emission levels) and equal per capita allocation of emission allowances would be less costly than carbon taxes for India to stabilize emissions. Shukla *et al.* (2008) use an integrated modeling framework, including a global multi-region and multi-sector CGE model, to study two alternative pathways for low-carbon growth in India — a pure carbon tax, and a combination of carbon tax with sustainable policies (assumptions on behavioral, technological, institutional, governance, and economic measures that promote sustainable practices). Ojha (2009) emphasizes the heterogeneity in households and the expectation that climate policies have different impacts on households belonging to different income and expenditure groups (Poterba, 1991; Bull *et al.*, 1994; Hassett *et al.*, 2009). Multiple households segregated by income levels are incorporated in a single country CGE model to study the distributional impacts of carbon policies on shifts in consumption patterns. Simulated climate policies include carbon tax and permit trading, with various revenue recycling options, and the findings echo those of Fisher-Vanden *et al.* (1997).

Our work offers significant improvement on three fronts. First, we employ carbon pricing as a benchmark policy to achieve India's actual climate targets and compare the impact of carbon pricing with that of combining it with an RPS that structurally mimics India's RPOs, instead of comparing the extent of emissions reduction likely to be achieved through hypothetical carbon tax and cap-and-trade schemes. We intend our analysis to be of value to policymakers by informing them of the impacts of the alternative instruments that can achieve India's climate targets. Secondly, our model includes an elaborate representation of India's electricity sector, particularly of the non-fossil electricity technologies, which enables our granular analysis of India's non-fossil electricity capacity targets. Finally, by capturing the unprecedented role of declining wind and solar power costs, we explore sensitivity of outcomes to these cost variations and evaluate their policy implications.

The remainder of this paper is structured as follows. In Sec. 2, we describe our modeling framework, data sources, and simulation scenarios. Results are presented and discussed in Sec. 3. Section 4 concludes.

2. Methodology

2.1. Modeling framework

We develop a multi-sector applied general equilibrium model of the Indian economy that links economic activity with energy production and CO₂ emissions from burning

fossil fuels. This structure builds in important economy-wide feedbacks associated with policy shocks; for instance, it reflects how a CO₂ price affects patterns of production and demand across all economic sectors by raising the cost of fossil fuel intensive activities. The model includes a representative agent for firms, households, and government. Firms employ primary factors (labor, capital, and natural resources) and purchase intermediate inputs to produce goods and services. Households own primary factors of production and provide them to firms, receive income from capital earnings, wages/salaries, resource rents, and transfers from the government, and pay taxes to the government. The government is a passive entity that collects taxes from households and producers to finance government consumption and transfers. Investment is modeled as a fixed proportion of expenditure by households to serve as a proxy for future consumption. Sectoral imports and exports capture interactions with the rest of the world. The model is calibrated using historical data and projections for macroeconomic variables and technology costs to generate a 2030 reference case, which is used as base to conduct comparative static analysis of policy impacts.

International trade is modeled following an Armington approach (Armington, 1969), where goods and services purchased by firms and households are composites of domestic and imported varieties. The elasticity of substitution between domestic and imported goods is set to zero reflecting the assumption that other countries will also pursue their Paris commitments, and as such, domestic goods may not see competitive threats (or advantages) imposed by higher (or lower) domestic energy prices as India pursues its commitments.⁴ Similarly, the elasticity of transformation between production for domestic and foreign markets is also set to zero. To get a sense of possible substitution effects, we include a sensitivity case with non-zero Armington elasticity and non-zero elasticity of transformation between production for domestic and foreign markets.

The economy of India is represented through 18 sectors (Table 1) aggregated from 68 sectors in the GTAP-Power database (Peters, 2016), which is based on the ninth version of the GTAP dataset (Aguilar *et al.*, 2016), and represents global economy in 2011. The data for the model are aggregated by extending the tools illustrated in Lanz and Rutherford (2016). The energy sector is described in significant detail, comprising of eight electricity sectors (including transmission and distribution) and four other energy sources, namely, coal, crude oil, gas, and refined oil. CO₂ emissions are produced by the consumption of fossil fuel sectors of coal, crude oil, and gas, by firms and households. Other major industrial sectors are aggregated in energy-intensive industries, manufacturing, and mineral production. Agriculture, food and beverages, and services include aggregation of the remaining sectors in the economy.

⁴Assessing changes in sectoral competitiveness due to cross-country differences in climate policies requires a global model. In our single-country framework, if desired, changes in world prices relative to those in India could be imposed in the model, once they are estimated elsewhere. We do not consider such relative price changes in this study.

Table 1. Sector specification in the model.

Category	Sectors	Category	Sectors
Energy — electricity	Coal power	Energy — other	Crude oil
	Gas power		Gas
	Hydro power		Refined oil
	Nuclear power	Major industries	Energy-intensive industries
	Oil power		Manufacturing
	Wind power		Mining and minerals
	Solar power		
	Transmission and distribution	Other	Agriculture
	Food		
	Services		
Energy — other	Coal		

The 18 sectors are each described by a separate multi-level nested constant elasticity of substitution (CES) production function with nesting structures to provide for substitution between energy composite, electricity, capital, labor, resources, and other intermediate inputs. An additional production function describes advanced solar technology as the benchmark data comprise of negligible solar power. Nested CES functions are also used to describe consumer, government, and investment sectors. All industries are characterized by constant returns to scale and trade in perfectly competitive markets.

Nesting structures are described in Fig. 1. Horizontal lines indicate zero elasticity of substitution between inputs whereas slanted lines indicate a non-zero elasticity.

Figure 1(a) represents the nesting structure of all sectors except agriculture, electricity, fossil fuel, and final consumption. Primary energy sources are grouped in the non-electricity energy nest and substitute with aggregate electricity. Final output comprises an energy composite, land, labor, capital, resources, and other intermediate inputs. Figure 1(b) represents agriculture, where land is moved from the value-added

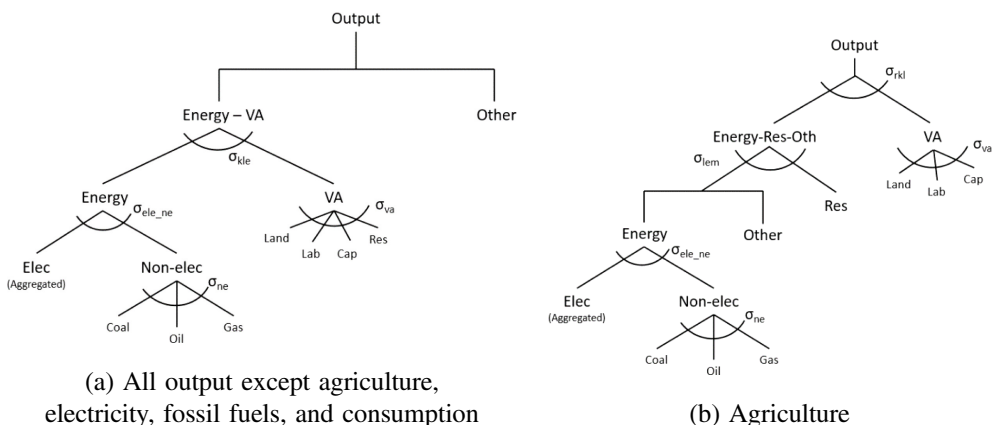

(a) All output except agriculture, electricity, fossil fuels, and consumption

(b) Agriculture

Figure 1. Nesting structures for production blocks in the India CGE Model.

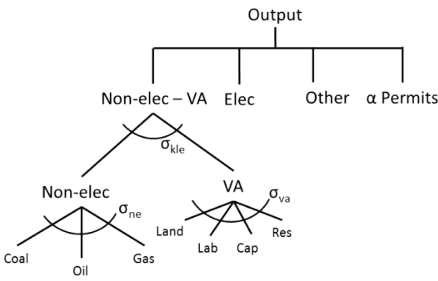

(c) Fossil electricity (coal, oil, gas)

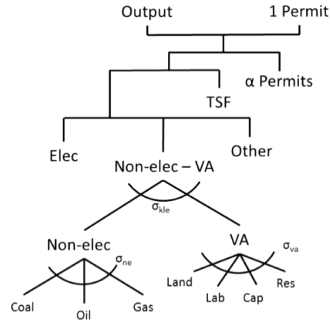

(d) Nuclear, hydro, and benchmark solar power

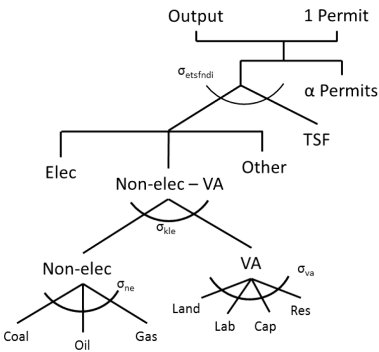

(e) Wind power

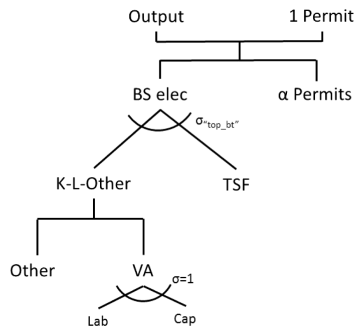

(f) Backstop solar power

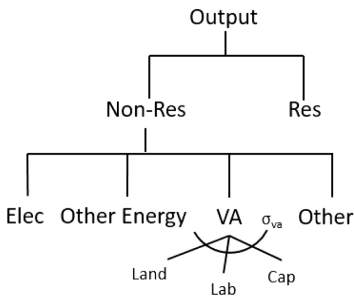

(g) Fossil fuel production

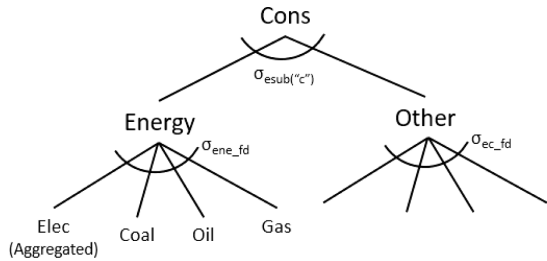

(h) Consumer, government, and investment

Fig. 1. (Continued)

nest to the energy and other Armington input nest, reflecting the significance of land for agriculture, and limiting its substitutability by allowing for a small elasticity of substitution with other inputs.

Electricity production is represented by three separate nesting structures for benchmark electricity sources, and one for advanced electricity technology to facilitate new solar penetration in policy scenarios. Figure 1(c) outlines fossil electricity production and includes renewable electricity credits to enforce prescribed non-fossil

electricity capacity targets through an RPS. Figures 1(d) and 1(e) for non-fossil electricity illustrate generation of certificates with electricity output. The expansion of non-fossil electricity capacity is constrained by technology specific fixed-factors (TSF). In principle, TSF represents resource and other political constraints that may impose barriers to growth of certain technologies.

We impose a zero elasticity of substitution between TSF and other inputs for nuclear, hydro, and benchmark solar power. Due to resource and political constraints, the growth of nuclear and hydro power is uncertain, and these technologies are represented by fixing targets for 2030 based on projections in IEA (2015). Besides, as most of India's current solar capacity has been added post 2011, the representation of solar power in the benchmark data (2011) is negligible. We therefore assume that the cost shares in benchmark solar are not representative and allow solar growth only as an advanced technology, restricting benchmark solar to its existing capacity.

The specification of wind power is different from other non-fossil electricity sources. Wind capacity in India is projected to grow considerably (IEA, 2015), with a government specified target of 60 GW installed capacity for 2022 (NITI Aayog, 2015). Besides, benchmark data include 2% wind power production (24 TWh), suggesting that our representation of cost shares is consistent with on-the-ground reality. We include a non-zero elasticity of substitution between other inputs and the TSF to offer flexibility in wind capacity expansion. The elasticity is estimated from price elasticity of supply and wind cost shares, using methods specified in Rutherford (2002) and supply elasticity value specified in Böhringer *et al.* (2012).

Solar expansion is represented as an advanced technology introduced as backstop technology (McFarland *et al.*, 2004). Figure 1(f) describes solar power generation using capital and labor as inputs, and constrained with a TSF. The TSF represents real world constraints on capital, labor, or other inputs, as well as intermittency challenges, which may limit the growth of advanced technologies (Morris *et al.*, 2014).⁵ Estimated cost shares are normalized to one and multiplied with a markup to represent the relative cost of advanced technology over the average cost of electricity. The markup is varied to perform a sensitivity analysis of solar penetration at different generation costs relative to those of non-solar electricity.

Finally, Figs. 1(g) and 1(h) represent fossil fuel production and consumption, respectively. By assuming India as a price taker in the international oil and gas market, the fossil fuel production function allows for fossil fuel prices to be specified exogenously by endogenously choosing the level of resources for each fossil fuel.

The model does not represent biofuels as a separate sector, and an elaborate representation of biofuels such as that found in Winchester and Reilly (2015) is beyond

⁵The TSF in a static model plays a different role than in a recursive dynamic model illustrated in Morris *et al.* (2014). In a recursive dynamic model, the TSF reflects dynamics of adoption and could become irrelevant over time as the incentives to adopt new technology lead to cost reductions. In a static model, as discussed, the TSF is employed as a mechanism to reflect factors not directly included in the model but which may constrain the growth of certain types of technologies.

the scope of this work. Indeed, while bioenergy production in India is poised for an increase, it does not feature as a prominent source of electricity in forecasts for India. The electricity capacity growth forecasts from IRENA (2017) project that by 2030 while installed power capacity will be comprised of between 36% and 56% of wind power and between 18% and 37% of solar PV (depending upon business-as-usual scenario or renewable-favorable policy scenario), it will include only about 4–5% of installed bioenergy-based power.

2.2. Data sources and parametrization

Cost shares in the production functions are parametrized from GTAP-Power database. Elasticity values for production blocks are provided exogenously and closely follow those in the MIT EPPA model (Chen *et al.*, 2015), which are drawn from an extensive literature review (Appendix A).

Advanced solar is parametrized bottom up using levelized cost of electricity estimates from NITI Aayog (2015). Operating and maintenance (O&M) costs over the project life are discounted to present value and added to capital expenditure (capex) to obtain PV of total costs, from which percentage capex and percentage O&M are derived (Appendix B). The cost share allocated to TSF is kept similar to that for wind power, conforming with an approach of treating wind and solar production equivalently (for instance, see Chen *et al.* (2015)).

Additional data required to simulate policy scenarios for 2030 are listed in Table 2. The required parameters include GDP growth in India from 2011 to 2030 (GDP multiplier), expected exogenous growth in fossil fuel prices (fossil fuel multipliers), expected efficiency improvements in energy production technologies (autonomous energy efficiency improvement — AEEI — multiplier), and factors for simulating India's NDC on emissions intensity and non-fossil targets.

Table 2. Required parameters for policy scenarios.

Parameter	Unit	Value	Source
GDP multiplier (2011–2030)	—	2.86	OECD (2017)
Fossil fuel price multipliers (2011–2030)			
Coal	—	1.00	
Oil	—	1.13	
Gas	—	1.13	U.S. EIA (2017)
AEEI multiplier	—	0.826	Chen <i>et al.</i> (2015)
Emissions intensity target for 2030	% of benchmark emissions intensity	71.06	GoI (2015); Appendix C
Non-fossil target for 2030	% of installed capacity	40	GoI (2015); Appendix D
Non-fossil production target for 2030	% of electricity production	28	

The GDP multiplier is based on long-term GDP forecasts from the [OECD \(2017\)](#). Reported in real terms in 2010 US\$ PPP, India's GDP grows from \$3.90 trillion in 2011 to \$11.16 trillion in 2030 at a compounded annual growth rate (CAGR) of 5.7%. This is a conservative estimate, considering that average annual GDP growth rate of India from 1992, when economic reforms were introduced, to 2015 has been 6.78% ([World Bank, 2015](#)). We also simulate high and low GDP growth scenarios and report key modeling outcomes under variations in GDP growth.

Fossil fuel multipliers specify exogenous increase in fossil fuel prices in 2030. We assume coal price to be constant as coal is not a scarce resource in India, it has been and is expected to continue being the mainstay of the power sector, and any domestic shortage due to logistical issues (seasonal variation, transport challenges) can be managed by better planning ([Tongia and Gross, 2019](#)). As crude oil prices fluctuate in the short and medium term, the crude oil price multiplier is obtained by smoothing the international crude oil price trend between 2001 and 2030, taking historical and projected prices from [U.S. EIA \(2017\)](#). The multiplier for natural gas price is the same as for crude oil, as natural gas prices are typically strongly correlated with crude prices ([Brown and Yücel, 2008](#)).

AEEI multiplier represents future improvements in energy production technologies, leading to lower inputs per unit energy produced. We derive AEEI multiplier from the MIT EPPA model ([Chen et al., 2015](#)), assuming 1% annual efficiency improvement, leading to 17.4% improvement from 2011 to 2030.

Calculation of emissions intensity targets is specified in [Appendix C](#).

Conversion of non-fossil electricity-installed capacity targets for 2030 to production targets is specified in [Appendix D](#). We first calculate aggregate fossil and non-fossil capacity factors (CF) for 2015 using installed electricity capacity and production values from [CEA \(2015\)](#) using Eq. (1):

$$CF = \frac{\text{Electricity Production}}{\text{Installed Capacity} * n_h * d_y}, \quad (1)$$

where $n_h = 24$ h and $d_y = 365$ days.

Percentage capacity targets for 2030 are then converted to percentage production targets using Eqs. (2) and (3), which can easily be derived from Eq. (1):

$$P_{nf}(\%) = C_{nf}(\%) * \left(\frac{CF_{nf}}{CF_{total}} \right), \quad (2)$$

$$P_f(\%) = C_f(\%) * \left(\frac{CF_f}{CF_{total}} \right), \quad (3)$$

where $P_{nf/f}(\%)$ is the percentage production level of non-fossil/fossil electricity; $C_{nf/f}(\%)$ is the percentage capacity of non-fossil/fossil electricity; and $CF_{nf/f/total}$ is the aggregate capacity factor for non-fossil/fossil/total electricity.

We assume that aggregate capacity factors for fossil and non-fossil electricity sources, respectively, in 2030 will be the same as in 2015, but a higher percentage of non-fossil electricity will decrease the aggregate capacity factor of the electricity sector.⁶ This leads to circularity as calculation of non-fossil electricity production levels for 2030 requires total capacity factor, but the total capacity factor depends on non-fossil electricity production levels. To address this, we iterate total capacity factor to arrive at percentage production levels of fossil and non-fossil electricity for 2030 that add up to 100%. This generates overall capacity factor of 0.44 (lower than 0.46 for 2015), and a non-fossil electricity production target of 28%. We include a sensitivity case in which all of India's targeted emissions intensity reduction is met through higher non-fossil electricity production.

The model is formulated as a mixed complementarity problem (MCP) (Mathiesen, 1985; Rutherford, 1995) in the Mathematical Programming System for General Equilibrium Modeling (MPSGE) (Rutherford, 1998) and the General Algebraic Modeling System (GAMS) modeling language. Using the PATH solver (Dirkse and Ferris, 1995), it is solved statically in two stages, reflecting the Benchmark economy in 2011 and reference as well as policy scenarios in 2030 (target year for India's NDC).

2.3. Scenarios

We implement a forward calibration simulation to first generate a 2030 Reference scenario. We include three policy scenarios to simulate instruments to achieve India's NDC targets and their combination. The reference as well as policy scenarios include the same assumptions about factor productivity growth, fossil fuel price in 2030, and AEEI.

Our policy scenarios are summarized in Table 3. In the Emissions-Intensity scenario, we impose India's NDC objective of reducing emissions intensity of the GDP by 34% (taking mean of proposed 33–35% reduction) by 2030 from 2005 levels.

Table 3. Policy scenarios for 2030 in the India CGE model.

Scenario	Description
Emissions-Intensity	An economy-wide emissions trading scheme reduces the emissions intensity of the GDP in 2030 to 28.94% lower than that in 2011
Non-Fossil	An RPS enforces that non-fossil electricity sources constitute 28% of India's electricity production in 2030 (40% of India's installed electricity capacity)
Combined	A combination of both Emission-Intensity and Non-Fossil scenarios

⁶Strictly speaking, the aggregate fossil and non-fossil capacity factors will also change. Fossil and non-fossil electricity sources are aggregates of different power sources with varying capacity factors, hence the aggregate capacity factors will change as constituent source mixes change. However, for simplicity, and in the absence of more information, we assume that the aggregate fossil and non-fossil electricity capacity factors remain same.

As described in Appendix C, this translates to a reduction by 28.94% from benchmark (2011) level. This is simulated as an economy-wide cap-and-trade policy with the emissions cap determined endogenously to satisfy a constraint on emissions relative to GDP. We evaluate the impact of this target on total and sectoral emissions, consumption, electricity mix, and also identify the corresponding carbon price.

The Non-Fossil scenario corresponds to India's non-fossil electricity capacity target for 2030. The target of 40% installed non-fossil electricity capacity by 2030 corresponds to 28% electricity production (Appendix D) and is imposed as an RPS. This provides information about independent impact of the non-fossil targets.

In practice, both emissions intensity and non-fossil electricity targets will be jointly pursued. The Combined scenario simulates this by combining economy-wide emissions trading with an RPS. While both Emissions-Intensity and Combined scenarios lead to the same emission intensity in 2030, the Combined scenario includes the additional constraint of non-fossil electricity targets. Comparing these scenarios offers a direct assessment of the implications of pursuing non-fossil electricity targets along with economy-wide emissions reduction.

Our base analysis fixes the cost of wind and solar power at levels that represent declines from their benchmark costs. The cost of wind power incorporates AEEI similar to those for fossil power, thus accounting for technological improvements, and the cost of solar power is fixed at parity with the average benchmark cost of electricity, reflecting the trend observed in certain recent solar auctions in India (LiveMint, 2017). However, there is considerable uncertainty in the variation of these costs in the future. IRENA (2016) projects that appropriate policy and regulatory frameworks may enable significant *additional* cost reductions in wind and solar power such that by 2025 the global weighted average LCOE of solar PV could fall by as much as 59% and that of onshore wind could fall by 26%, relative to 2015. In India, the winning bids in utility-scale solar auctions have dropped by over 350% between 2010 and 2017, supported not only by technological cost declines but also by favorable policies including federal and state-level renewable targets (Thapar *et al.*, 2018). Similar cost variations in the future could have substantial impact on the welfare implications of the policy alternatives required to achieve India's NDC. This motivates our inquiry into the impact of additional policy-induced cost declines beyond the technological improvements in the base analysis. The renewable cost variations are simulated exogenously such that the cost of wind power expansion is varied by altering the elasticity of substitution between TSF and other inputs and of solar power by altering the markup. The supply elasticity for wind electricity in the base case is 12.66 (Böhringer *et al.*, 2012), which corresponds to an elasticity of substitution of 0.29 between the TSF and other inputs. Solar cost share markup in base case is set to 1. These specifications provide a sensible comparison across policies at fixed costs of wind and solar power. As the cost variations represent policy-induced changes, the reference case is not re-run in the sensitivity analyses.

3. Results

3.1. Scenarios with fixed costs of wind and solar power

First, we simulate the three policy scenarios while holding wind and solar power costs fixed. Table 4 summarizes key base results through indicators representing annual values in the commitment year of 2030. We first compare the cost of emission reduction under different policies (Fig. 2) through the decrease in consumer welfare from reference, measured as the Hicksian equivalent variation (EV). Welfare loss is the

Table 4. Summary of key base results (all dollar values are in 2011 US \$).

Indicator	Unit	Scenarios			
		Reference	Emissions-Intensity	Non-Fossil	Combined
Welfare loss (w.r.t. reference)	US\$/tCO ₂ reduced		1.27	13.01	9.60
Emissions	Million tCO ₂	4567.62	3591.65	3824.01	3572.25
Total welfare loss	Billion US\$		1.24	9.67	9.56
Emissions intensity	tCO ₂ /US\$	0.79	0.62	0.66	0.62
Carbon price	US\$/tCO ₂		23.38		6.17
Total electricity production	TWh	3070.97	2825.12	2427.72	2416.89
Fossil electricity	TWh	2678.54	2278.89	1756.00	1746.26
Non-fossil electricity	TWh	392.43	546.23	671.73	670.64

Note: The numbers in the table are annual values in 2030.

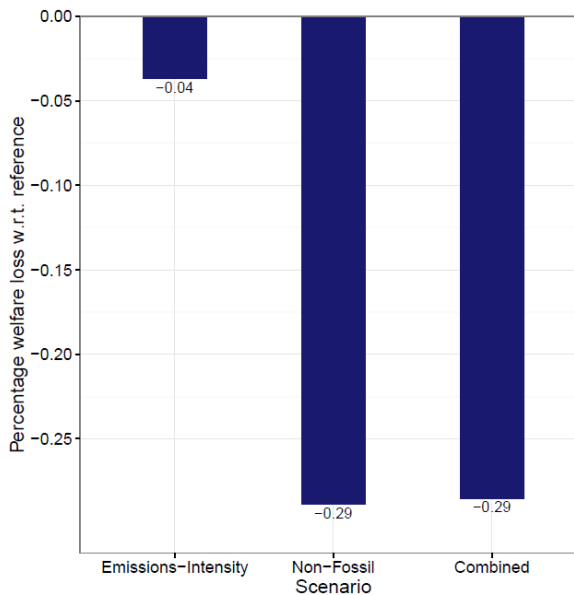

Figure 2. Change in consumption from reference under different scenarios in 2030.

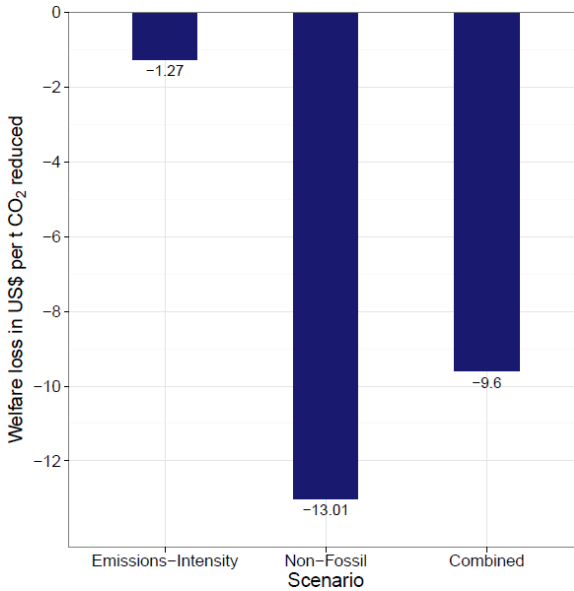

Figure 3. Change in consumption per unit emission reduction under different scenarios in 2030.

lowest under Emissions-Intensity (0.04%) and significantly higher under non-fossil and combined policy scenarios (0.29% under each). A better indicator to compare the efficiency of different policies in reducing emissions is the welfare loss per metric ton (t) of CO₂ reduced (Fig. 3). Compared with reference, the cost of reducing a metric ton of CO₂ is lowest in the Emissions-Intensity scenario and is more than 10 times higher in the non-fossil scenario, reflecting the efficiency of economy-wide emission reduction policies. Simulating both cap-and-trade and RPS in the Combined scenario results in a decline in welfare loss per unit of emission reduction over the Non-Fossil scenario. This is because some low-cost emissions reduction measures are incentivized by economy-wide carbon pricing, reducing the average cost of emission reduction. Notably, the carbon price to achieve the required emission reduction drops significantly in the Combined scenario, as most of the targeted emission reduction is achieved through the mandatory RPS. Thus, imposing non-fossil electricity in the mix has the twin impact of increasing welfare loss but decreasing the carbon price.

Next we compare reductions in emissions and emissions intensity. As expected, in all policy scenarios, total emissions as well as emissions intensity decrease relative to the reference. The Emissions-Intensity scenario sees emissions decline by 27% over reference, whereas consumption per metric ton of emissions reduction falls modestly. Non-Fossil electricity targets result in 6% higher emissions than under the emissions intensity target, while achieving 76% of the NDC target emissions intensity reduction. They are also significantly more costly in terms of welfare loss, compared with using pricing to achieve target CO₂ intensity.

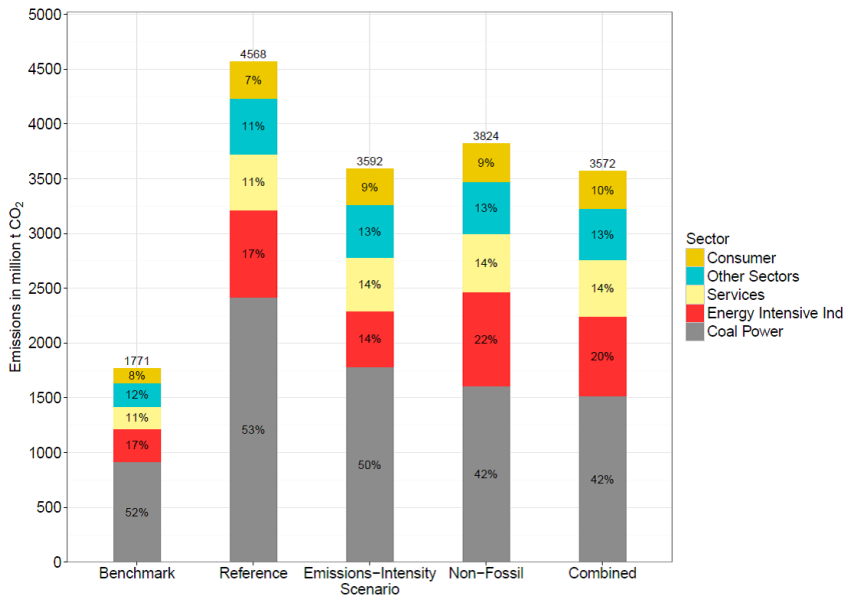

Figure 4. Emissions by sector in 2030 under different scenarios.

Figure 4 illustrates emissions from the four highest emitting sectors, namely, coal power, energy-intensive industries, services, and consumer, and combines emissions from the remaining sectors in “Other Sectors” under all scenarios. The significant decline in emissions under the Emissions-Intensity scenario is driven by reductions in emissions from coal power and energy-intensive industries. However, under the Non-Fossil scenario, total emissions do not decline to equivalent levels as emission reductions in coal power are more than offset by increased emissions in energy-intensive industries as they substitute expensive electricity with (now cheaper) direct use of fossil-based energy sources. In other words, emissions leak to non-target sectors under sector-specific policies.

Figure 5 describes the electricity mix under different scenarios in 2030. In the Reference case, total electricity production in India is projected to be nearly three times the level in 2011. Most of the increase comes from expansion of coal power, which more than triples in 2030. Other fossil-based electricity sources also increase by varying amounts. Among non-fossil electricity sources, hydro power rises to its allowed scope for expansion but nuclear power production is less than the maximum allowed in the model, and return to the nuclear TSF falls to zero. This reflects the higher cost of producing nuclear power compared with thermal power, which restricts its expansion in a no-policy scenario. The share of wind power in the reference also does not rise significantly beyond benchmark level, suggesting that even though wind has a non-trivial share in benchmark, the cost of producing wind power is still high relative to thermal power. Thus, without favorable policies, wind power may see only

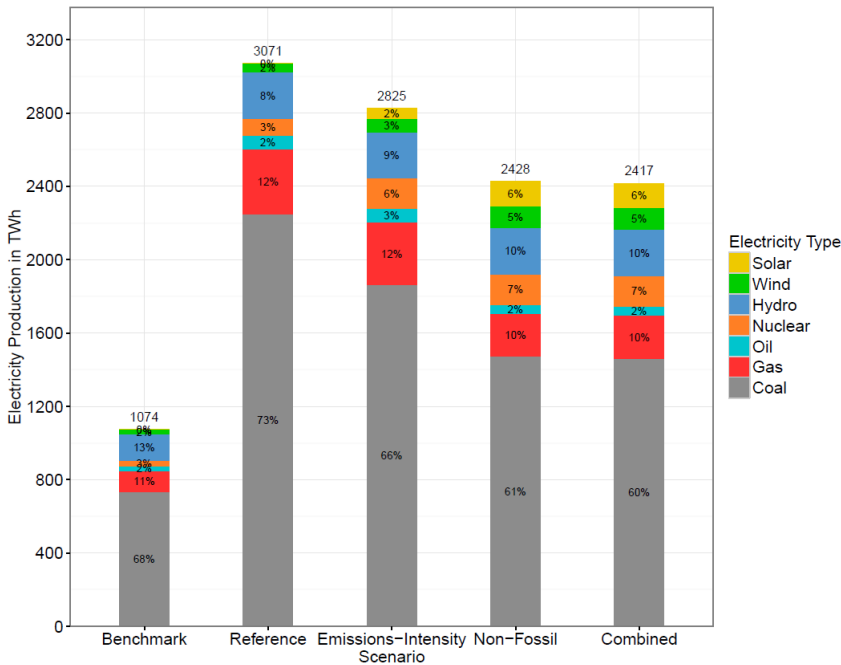

Figure 5. Electricity mix in India in 2030 under different scenarios.

moderate expansion. Further, in the absence of favorable policies, solar power is unlikely to see any growth.

Electricity production in 2030 drops by 8% in the Emissions-Intensity scenario. As carbon content per energy unit is highest for coal, most of the decrease comes from a reduction in coal power, affirmed by a relatively smaller drop in gas power. Both nuclear and hydro power reach their maximum allowable level. Besides, wind penetration increases slightly, indicating that with fossil electricity sources becoming more expensive, renewable power will compete with them in adding to the total electricity production. A higher share of solar, driven by advanced solar technology, further underscores the competitiveness of renewable electricity under emission constraints. Overall, total electricity demand drops as the average electricity price increases to account for more expensive fossil power and a higher share of non-fossil power.

Electricity production drops further in the Non-Fossil and Combined scenarios. Introducing a higher share of expensive non-fossil electricity in the mix (28% in non-fossil and combined compared with 13% in reference and 19% in emissions-intensity) increases the price of electricity, consequently reducing demand by an additional 14% over Emissions-Intensity scenario. All fossil electricity sources see a decline, whereas shares of non-fossil sources increase. Under the Combined scenario, the electricity mix is similar to that in Non-Fossil scenario, as the additional emissions reduction mandated by the emissions intensity target in the Combined scenario is achieved more cost-effectively through sectors other than the electricity sector.

In Table 5, we report the sensitivity of the base results to scenarios with (i) a higher non-fossil target that can, in and of itself, achieve India's emissions intensity commitment, (ii) high and low GDP growth scenarios, and (iii) non-zero elasticity of substitution between domestic and imported goods and non-zero elasticity of transformation between goods produced for domestic and export markets. To achieve the targeted emissions-intensity reduction solely through higher non-fossil electricity generation, the electricity production from non-fossil sources is about 33% as against 28% in the baseline (corresponding to an installed capacity share of about 46% as against 40% in the baseline). This higher non-fossil capacity addition corresponds to higher welfare losses. Under high GDP growth, achieving India's commitments imposes higher welfare costs and requires a higher carbon price in the Emissions-Intensity scenario compared with these outcomes with the baseline GDP growth assumption. The non-fossil electricity target, however, substantially restricts the expansion of the power sector and enables meeting the emissions-intensity reduction target at no additional welfare costs. Under low GDP growth, the welfare costs of achieving India's commitments and the required carbon price in the Emissions-Intensity scenario are lower than those under the baseline GDP growth assumption. Finally, allowing for substitution between domestic and imported inputs (and between products for domestic and foreign markets) lowers the carbon prices required to impose emission constraints, as this substitution provides an additional abatement option. The sensitivity analysis confirms our key findings that the welfare costs of emissions reduction are the lowest under an economy-wide CO₂ pricing instrument and the addition of sector-specific policies increases the welfare costs while lowering the carbon price required to achieve the targeted emissions-intensity reduction.

3.2. *The impact of alternative wind and solar costs*

While our base analysis suggests that an RPS prescribing non-fossil targets adds considerably to the cost of emissions reduction, the cost difference depends significantly on the cost at which non-fossil electricity is available. In the following analyses, we evaluate how policy-induced changes in wind and solar power costs would interact with policy outcomes.

Variation in wind power cost is simulated by adjusting the elasticity of substitution between the TSF and other inputs in the wind production block. Conceptually, a higher elasticity of substitution indicates reduced impact of the TSF constraint, leading to cheaper expansion of wind power. Variation in substitution elasticity thus serves as a proxy for the variation in future wind power expansion cost. Cost variation for solar power is simulated directly by varying the markup on the cost of production. Conceptually, this may indicate availability of cheaper capital, policy changes for improved offtake and better regulatory enforcement, among other improvements. Solar cost variation can also be simulated by varying the substitution elasticity between TSF and other inputs, but the outcome will be similar.

Table 5. Sensitivity of modeling outcomes to higher non-fossil electricity targets, high and low GDP scenarios, and non-zero substitution between domestic and imported inputs and produced goods and services.

Indicator	Unit	Sensitivity scenarios									
		Emissions intensity reduction through only non-fossil electricity targets	GDP — high	GDP — low	Allowing substitution between domestic and imported inputs and produced goods and services	Emissions- Non-Fossil Intensity	Non-Fossil Combined	Emissions- Non-Fossil Intensity	Non-Fossil Combined		
		Non-Fossil electricity production in 2030 is 33% against baseline 28%	GDP CAGR between 2011 and 2030 assumed as 7.5%* (World Bank, 2019) ⁷ resulting in a GDP multiplier of 3.95 against baseline 2.86	GDP CAGR between 2011 and 2030 assumed as 5% resulting in a GDP multiplier of 2.53 against baseline 2.86	Elasticity of substitution between domestic and imported inputs (Armington elasticity) set to 3 instead of 0; elasticity of transformation between goods produced for domestic and export markets set to 1 instead of 0						
Welfare loss (w.r.t. reference)	US\$/tCO ₂ reduced	28.31	2.08	46.61	46.61	5.96	3.70	6.74	19.73	15.32	
Emissions	Million tCO ₂	3532.19	4957.14	4819.74	4819.74	3178.06	3171.45	3587.47	3853.50	3571.43	
Total welfare loss	Billion US\$	29.32	2.98	73.12	73.12	0.83	3.11	6.43	13.58	14.87	
Emissions intensity	tCO ₂ /US\$	0.62	0.62	0.62	0.62	0.62	0.68	0.62	0.67	0.62	
Carbon price	US\$/tCO ₂		28.53		0	21.28	9.39	18.45		5.99	
Total electricity production	GWh	2079.65	3786.31	2397.97	2397.97	2480.04	2234.13	2795.67	2461.64	2426.36	

Notes: ^{*}The GDP growth forecasts in the Global Economic Prospects report of the World Bank (World Bank, 2019) project India's GDP growth as 7.5% per year until 2021/22. We assume the same growth rate until 2030 for the high GDP growth rate scenario.

3.2.1. Carbon price and welfare loss under different scenarios and alternative costs of wind power expansion and solar power

Table 6 illustrates how two metrics vary with the cost of wind power expansion and of solar power: first, the observed carbon price to implement the emissions intensity target with and without the RPS in Emissions-Intensity and Combined scenarios, respectively, and second, the welfare loss under the two scenarios. The base results are highlighted. All scenarios listed here lead to India's target emissions intensity for 2030.

Our results highlight several tradeoffs between the political feasibility and cost effectiveness of economy wide and sector-specific policies. The following outcomes are noteworthy:

- (i) Economy wide emission intensity targets lead to significantly higher carbon prices compared to those in Combined targets. Carbon prices are higher to achieve the required reduction in the absence of additional binding constraints. In the Combined scenario, the RPS increases average electricity prices, resulting in a decline in electricity demand and consequently in emissions. The remaining emission reduction required to meet the emissions intensity target is achieved through low-cost emissions reduction measures resulting in lower carbon prices.

Table 6. Comparison of carbon price and cost of emission reduction under different scenarios.

Scenario	Carbon price		Welfare change	
	Emissions-Intensity	Combined	Emissions-Intensity	Combined
Wind elasticity	US\$ (2011) per tCO ₂	US\$ (2011) per tCO ₂	US\$ (2011) per tCO ₂ reduced	US\$ (2011) per tCO ₂ reduced
0.15	24.48	2.81	-1.48	-19.30
0.20	24.17	3.61	-1.42	-16.13
0.25	23.77	4.81	-1.34	-12.55
0.29	23.38	6.17	-1.27	-9.60
0.35	22.64	8.87	-1.15	-5.70
0.40	21.84	11.16	-1.02	-3.44
0.45	20.82	12.79	-0.87	-2.02
Solar markup				
1.3	25.73	4.83	-1.97	-15.12
1.2	25.73	5.20	-1.97	-13.48
1.1	24.49	5.64	-1.71	-11.65
1.0	23.38	6.17	-1.27	-9.60
0.9	22.46	6.82	-0.70	-7.29
0.8	21.49	7.63	0.09	-4.71
0.7	20.37	8.65	1.18	-1.81

Note: Increasing wind elasticity means lower expansion costs, while falling solar markup corresponds to lower input costs.

Thus, combining a carbon pricing policy with non-fossil electricity capacity targets may result in politically feasible carbon prices.

- (ii) Under Emissions-Intensity scenario, as expected, carbon price decreases with cheaper wind and solar power as the marginal abatement cost drops. On the contrary, cheaper wind and solar power in the Combined scenario is associated with *increases* in the carbon price. This is explained by the opposing impacts of cheaper renewable power in a capacity-based RPS policy. While cheaper renewable power facilitate emissions reduction through larger capacity addition, they also increase total electricity demand due to lower average electricity costs. Higher electricity demand may increase fossil electricity production (see Figs. 8 and 9).
- (iii) The overall impact is dominated by rising emissions (Fig. 7) and consequently higher carbon prices.
- (iv) Emissions-Intensity scenario sees lower welfare loss compared with the Combined scenario and may even lead to minor welfare gains relative to the Reference scenario. While reduction in welfare loss follows directly from the efficiency of economy-wide carbon policies, welfare gains occur likely due to a combination of technology advancements freeing up labor and capital from solar power production at the cheapest levels and carbon pricing potentially correcting certain pre-existing tax/subsidy distortions. Indeed, energy, including electricity, is heavily subsidized in India. IISD (2018) reported that the oil subsidies in India may amount to about US\$7.4 billion in the financial year 2018–2019, whereas Mayer *et al.* (2015) indicated that about 87% of all residential electricity consumption in India is subsidized. A significant reduction in energy-intensive industries (which includes transport) and in coal power, which is the main benchmark electricity technology, might be contributing to welfare gains.⁷ On the contrary, Combined scenario results in higher welfare losses, higher by 7.5 times on a per tCO₂ basis in the base case. Thus, while combined targets may lead to politically feasible carbon prices, the higher welfare loss highlights their lower economic efficiency in reducing emissions.
- (v) The welfare loss decreases with cheaper wind and solar power in both scenarios. This follows directly from the availability of cheaper electricity and, consequently, the comparatively lower reduction in electricity demand.

3.2.2. Impact of alternative wind and solar costs on policy outcomes

Figure 6 shows the costs in terms of welfare loss per metric ton of CO₂ reduced under different scenarios that vary in the cost of wind and solar power. Owing to low levels of wind and solar penetration in Emissions-Intensity scenario, the welfare loss is small

⁷While not a part of our analysis, removing distortionary energy subsidies could be an important policy pathway for India to reduce emissions. Chepeliev *et al.* (2018) illustrate how removal of energy subsidies can be incorporated in the GTAP database.

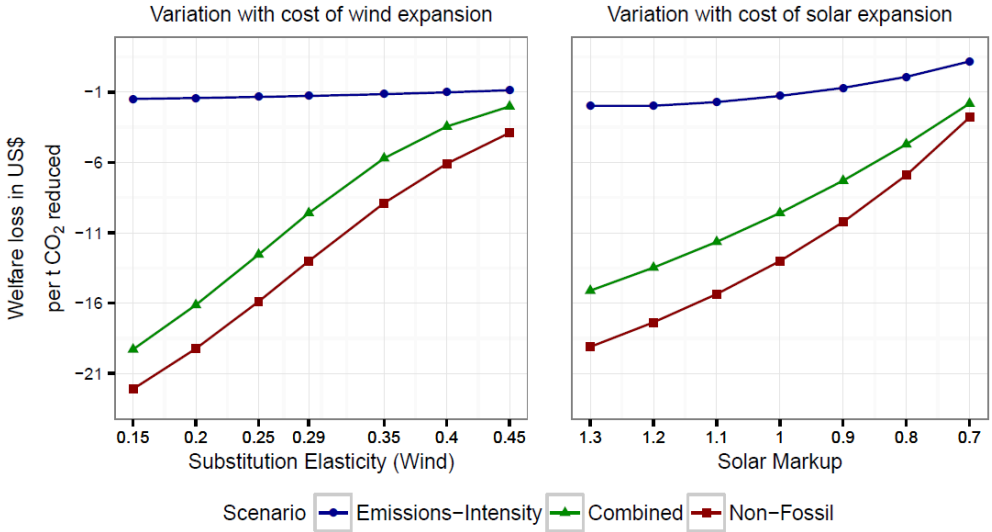

Figure 6. Variation in welfare loss per unit emission reduction with varying cost of wind and solar power expansion.

and further decreases at lower wind and solar costs. In the Non-Fossil and Combined scenarios, the cost of emission reduction is significantly higher at expensive wind and solar power but drops sharply with decreasing costs of wind and solar power. These results illustrate that at low renewable energy costs, achieving both economy wide targets as well as sector-specific targets can be similar in cost.

Further, as Fig. 7 shows, final emission levels in combined and emissions-intensity scenarios are similar — an outcome ensured by the emissions intensity limits in both

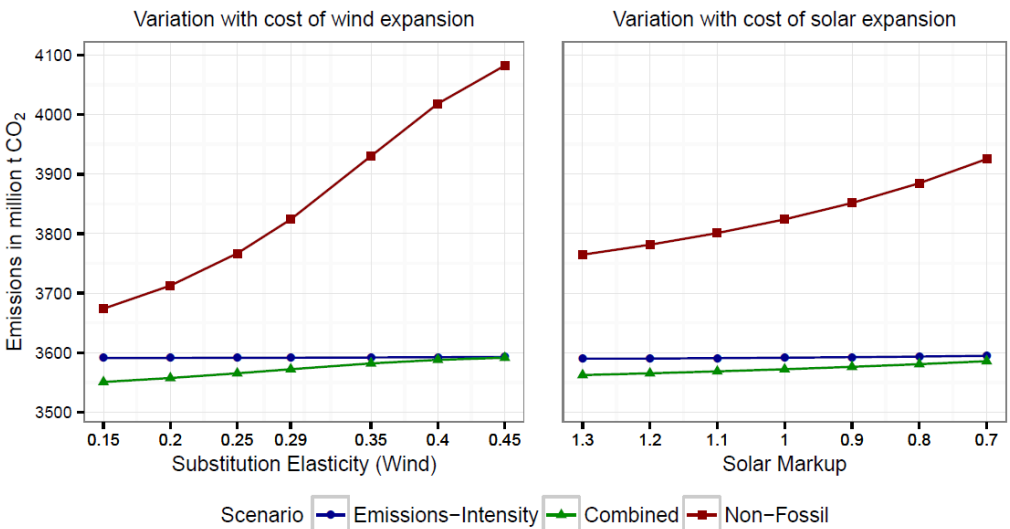

Figure 7. Variation in total emission with varying cost of wind and solar power expansion.

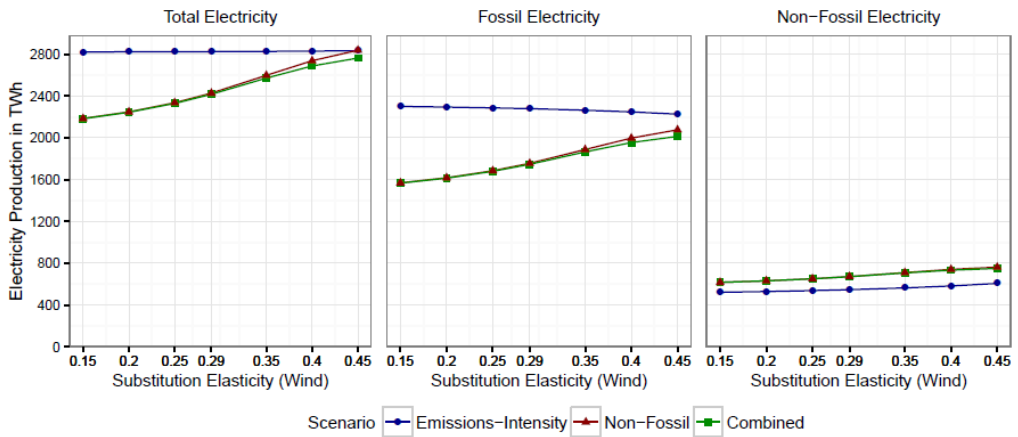

Figure 8. Variation in electricity production with varying costs of wind power expansion.

scenarios. The Non-Fossil scenario by itself cannot achieve the target emissions reduction and in fact leads to higher emissions as wind and solar power become cheaper. This is explained by higher total electricity levels at cheaper wind and solar power under an RPS.

Electricity levels at different costs of wind and solar expansion are plotted in Figs. 8 and 9. In the Emissions-Intensity scenario under a carbon price, cheaper wind and solar power drives down marginal CO₂ abatement cost and lead to higher levels of non-fossil power to achieve emissions targets (panel 3: blue line), accompanied by a decline in fossil power (panel 2: blue line). On the contrary, when non-fossil capacity targets are included under Non-Fossil and Combined scenarios, the availability of cheaper wind and solar power in the electricity mix decreases the average electricity price, resulting in an overall demand pull, and consequently higher levels of fossil electricity as well (panel 2: green and red lines), while maintaining the required non-fossil power

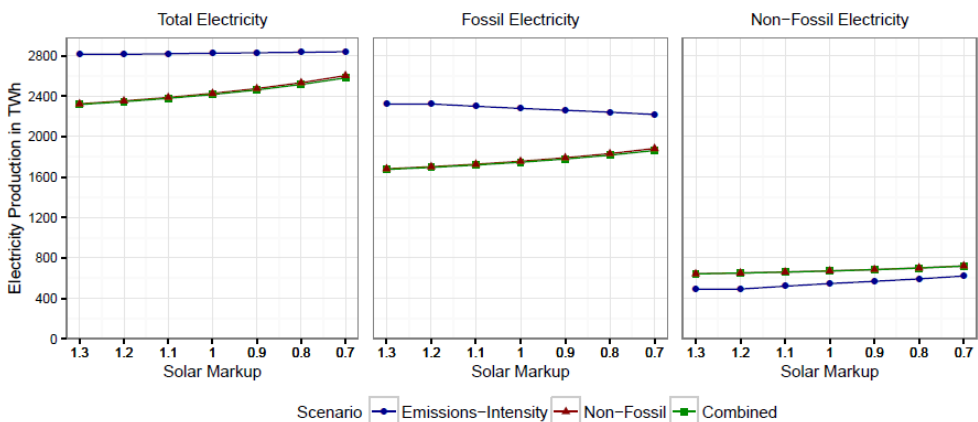

Figure 9. Variation in electricity production with varying costs of solar power.

production share of 28%. This is consistent with the lower welfare losses and increased emission levels under the non-fossil and combined scenario observed in Figs. 6 and 7, respectively. Nevertheless, the total electricity levels in Non-Fossil and Combined scenarios continue to be lower than those in the Emissions-Intensity scenario and are comparable only at very low costs of wind expansion.

4. Conclusion

We have employed a CGE model of the Indian economy with detailed representation of the electricity sector to analyze the impacts of India's climate targets. In particular, we have analyzed the implications of non-fossil electricity targets as a means to achieve India's emissions intensity reduction targets, by assessing their impact on consumer welfare, electricity mix, and sectoral emissions. We have also looked at the interaction of variable wind and solar costs with policy outcomes.

We find that an economy-wide emissions reduction policy simulated through a carbon price results in the lowest decline in consumer welfare to achieve the target emissions intensity. Further, emissions decrease across all fossil energy-consuming sectors and not only in the electricity sector. On the contrary, including non-fossil electricity capacity targets through an RPS increases the cost of emissions reduction by enforcing expensive non-fossil electricity in the mix. Additionally, it leads to leakage of emissions to non-electricity energy-intensive industries, as they may substitute electricity for coal or other cheaper fossil fuels.

Under a pure carbon pricing policy without an RPS, the model predicts a carbon price of \$23.38/tCO₂ (in 2011 US\$) to achieve the mean of India's NDC target of 33–35% reduction in emissions intensity of the GDP in 2030 over 2005 level. This price is higher than the carbon prices currently observed in most developed nations (Jenkins and Karplus, 2016), suggesting that it could be politically unacceptable. Enforcing an RPS to achieve India's non-fossil targets brings down the price to US\$ 6.17/tCO₂, which is likely to gain traction. However, consumer welfare loss is higher when an RPS is combined with a carbon price, largely due to more expensive electricity. The implications of lower but concentrated carbon price and higher but dispersed welfare loss need to be considered while comparing the political feasibility of alternative policies.

The global and national decline in wind and solar costs motivates our inquiry into the interaction of above policy outcomes with varying costs of wind and solar power. As expected, welfare losses under the a carbon price plus RPS decrease sharply at lower wind and solar costs and are only slightly higher than those under a pure carbon price at the lowest cost levels that we simulate. This suggests that declining wind and solar costs may pave the way for more aggressive decarbonization policies in the future, without compromising India's economic development objectives.

Certain limitations of our work are noteworthy and suggest directions for future research. First, the current version of the model solves statically in two states — 2011 and 2030. The model could be made recursive dynamic to study the pathways of policy

impacts from the present to 2030, which would allow for a more careful resolution of path dependence in technology adoption and inter-period dynamics. This would also allow assessment of whether intermediate policy objectives (such as the renewable targets for 2022) would be achieved under proposed policies. Secondly, the electricity demand growth in the model is currently driven by GDP growth and excludes the exogenous increase that will result from expanding electricity access. We intend to simulate expansion of energy access in future work. Thirdly, with one representative household, the model does not capture income and expenditure heterogeneity among households in India. Incorporating household heterogeneity in the model can provide valuable insights into the impact of climate policies across diverse income groups. Fourth, given the high levels of urban air pollution in India, reduction in fossil fuel usage is likely to have associated air quality co-benefits. Demonstrating the air quality co-benefits and their welfare impact will, however, require an atmospheric chemistry model and appropriate exposure-response functions, which are beyond the scope of this work.⁸ This paper serves as a strong foundation for expanding our work in these directions.

Acknowledgments

This work was supported in part by a research fellowship provided to Arun Singh by the MIT Tata Center for Technology and Design, which was established by a generous grant from the Tata Trusts. We thank the Energy Information Administration of the US Department of Energy for support to MIT through a cooperative agreement. We also thank the MIT Joint Program on the Science and Policy of Global Change for in-kind support.

Appendix A. Important Elasticity Values Used in the Model

Elasticity	Description	Value
σ_{kle}	Elasticity of substitution between energy and VA nests	0.40
σ_{ele_ne}	Elasticity of substitution between electricity and non-electricity inputs	0.50
σ_{ne}	Elasticity of substitution within non electricity inputs (coal, oil, gas)	1.00
σ_{rkl}	Elasticity of substitution between res and capital-labor in agriculture	0.20
σ_{lem}	Elasticity of substitution between land and energy materials in agriculture	0.30
$\sigma_{etsfindi}$	Elasticity of substitution between the TSF and other inputs	0.29
σ_{top_bt}	Elasticity of substitution between TSF and other inputs for backstop technology	0.29
$\sigma_{esub('c')}$	Top level elasticity in final demand	0.25
σ_{ene_fd}	Elasticity of substitution between energy sources in final demand	0.40
σ_{ec_fd}	Elasticity of substitution between energy and other consumption in final demand	0.25

⁸For analyses of country-level air-quality co-benefits of carbon pricing policies that combine economic models with atmospheric chemistry models, see, for instance, [Li et al. \(2018\)](#) and [Thompson et al. \(2014\)](#).

Appendix B. Bottom-Up Estimation of Cost Shares for Solar Power (NITI Aayog, 2015)

Parameter	Unit	Value
Capex (2015–16)	INR million/MW	60
O&M — 1st year (P)	INR million/MW/year	1.23
Project life (n)	Years	25
O&M escalation (g)	%	5.72
Discount rate (r)	%	11
PV of O&M	INR million/MW	16.41
PV of total costs (Capex + PV of O&M)	INR million/MW	76.41
Capex as % of PV of costs	%	78.5
O&M as % of PV of costs	%	21.5
TSF input to backstop	%	2.2
Non TSF inputs to backstop	%	97.8
Capital input	%	76.8
Labor input	%	21.0

Appendix C. Calculation of Emissions Intensity Target

Parameter	Unit	Value
Benchmark emissions	Million MT CO ₂	1771.2
Benchmark GDP	Billion USD (2011)	2034.6
Benchmark emissions intensity of GDP	MT CO ₂ /thousand USD (2011)	0.8705
Base year	Year	2005
Benchmark year	Year	2011
Target year	Year	2030
Total required decrease in emissions intensity*	%	34
Percentage decline in emissions intensity between 2005 and 2011 [†]	%	5.06
Required decline in emissions intensity between 2011 and 2030	%	28.94
Emissions intensity in 2030 as percentage of that in 2011	%	71.06
Target emissions intensity in 2030	MT CO ₂ /thousand USD (2011)	0.62

Notes: *India's NDC in [GoI \(2015\)](#) mentions a reduction in emissions intensity of the GDP by 33–35% by 2030 over 2005 levels. We take the mean value of 34% for our analysis.

[†]Obtained from CO₂ emissions intensity data reported in [World Bank \(2014a\)](#).

Appendix D. Conversion of non-fossil Electricity Capacity Targets for 2030 to Production Targets

Parameter	Fossil	Non-fossil	Total
Installed capacity in 2015 (GW)	188.898	82.824	271.722
Electricity production in 2015 (GWh)	878,320	227,126	1,105,446
Capacity factor (2015)	0.53	0.31	0.46
Assumed capacity factor (2030)	0.53	0.31	0.44
Installed capacity target for 2030	60%	40%	100%
Production target for 2030	72%	28%	100%

References

- Aguiar, A, B Narayanan and R McDougall (2016). An overview of the GTAP 9 data base. *Journal of Global Economic Analysis*, 1(1), 181–208.
- Aldy, J and RN Stavins (2012). The promise and problems of pricing carbon: Theory and experience. *Journal of Environmental Development*, 21, 152.
- Armington, PS (1969). A theory of demand for products distinguished by place of production. *International Monetary Fund, Staff Papers*, 16(1), 159.
- Bertram, C *et al.* (2015). Complementing carbon prices with technology policies to keep climate targets within reach. *Nature Climate Change*, 5(3), 235–239. Available at <http://www.nature.com/doi/10.1038/nclimate2514>.
- Böhringer, C *et al.* (2012). Green jobs and renewable electricity policies: Employment impacts of Ontario's feed-in tariff. *B.E. Journal of Economic Analysis and Policy*, 12(1).
- Brown, SPA and MK Yücel (2008). What drives natural gas prices? *Energy Journal*, 29, 45. Available at <http://mail1.dallasfed.org/research/papers/2007/wp0703.pdf>.
- Bull, N, KA Hassett and GE Metcalf (1994). Who pays broad-based energy taxes? Computing lifetime and regional incidence. *Energy Journal*, 15(3), 145–164.
- CEA (2015). Growth of electricity sector in India From 1947–2015. Available at: <https://www.researchgate.net/file.PostFileLoader.html?id=540615afd4c118e8508b4676&assetKey=AS%3A273591663300617%401442240745561>.
- CEA (2019). All India installed capacity (in MW) of power stations. Available at http://www.cea.nic.in/reports/monthly/installedcapacity/2019/installed_capacity-02.pdf.
- Chen, Y-HH *et al.* (2015). The MIT EPPA6 model: Economic growth, energy use, emissions, and food consumptions. *Joint Program Report Series Report 278(278)*, p. 40.
- Chepeliev, MG, RA McDougall and MD Van Der (2018). Including fossil-fuel consumption subsidies in the GTAP data base. *Journal of Global Economic Analysis*, 3(1), 84–121.
- Coase, R (1960). The problem of social cost. *Law and Economics*, 3(1), 1–44. Available at <http://www.jstor.org/stable/724810>.
- Dirkse, SP and MC Ferris (1995). The path solver: A nonmonotone stabilization scheme for mixed complementarity problems. *Optimization Methods and Software*, 5(2), 123–156.
- Economic Times (2017). Coal cess is part of GST compensation fund: Piyush Goyal, Energy News, ET EnergyWorld. *Times of India*. Available at <http://energy.economictimes.india-times.com/news/coal/coal-cess-is-part-of-gst-compensation-fund-piyush-goyal/59684982> [accessed 11 September 2017].

- Eisenhardt, KM (1989). Agency theory? *Agency Theory: An Assessment and Review*, 14(1), 57–74.
- Fisher-Vanden, KA *et al.* (1997). Carbon taxes and India. *Energy Economics*, 19, 289–325.
- GoI (2015). Press statement India's intended nationally determined contribution, October, pp. 1–8.
- Hassett, KA, A Mathur and GE Metcalf (2009). The incidence of a U. S. Carbon Tax: A lifetime and regional analysis. *Energy Journal*, 30(2), 157–180. Available at <http://www.scopus.com/inward/record.url?eid=2-s2.0-65649153153&partnerID=40&md5=4f6f17aff485ef6ce36b29701bd81fcc>.
- IEA (2015). *India Energy Outlook — World Energy Outlook Special Report*, Available at <https://www.iea.org/publications/freepublications/publication/india-energy-outlook-2015.html>.
- IISD (2018). *India Energy Subsidy — December 2018*, Available at <https://www.iisd.org/library/india-energy-subsidy-briefing-december-2018>.
- IRENA (2017). *Renewable Energy Prospects for India, a Working Paper Based on REmap*, Abu Dhabi: The International Renewable Energy Agency (IRENA). Available at <https://www.irena.org/publications/2017/May/Renewable-Energy-Prospects-for-India>.
- IRENA (2016). *The Power To Change: Solar and Wind Cost Reduction Potential*, Abu Dhabi. Available at http://www.irena.org/DocumentDownloads/Publications/IRENA_Power_to_Change_2016.pdf.
- Jenkins, JD (2014). Political economy constraints on carbon pricing policies: What are the implications for economic efficiency, environmental efficacy, and climate policy design? *Energy Policy*, 69, 467–477.
- Jenkins, JD and VJ Karplus (2016). Carbon pricing under binding political constraints. *UNU-WIDER*, (April), p. 47.
- Lanz, B and TF Rutherford (2016). GTAPINGAMS: Multiregional and small open economy models. *Journal of Global Economic Analysis*, 1(2), 1–77.
- Li, M *et al.* (2018). Air quality co-benefits of carbon pricing in China. *Nature Climate Change*. Available at <http://dx.doi.org/10.1038/s41558-018-0139-4>.
- Lipsey, RG and K Lancaster (1956). The general theory of second best. *The Review of Economic Studies*, 24(1), 11–32. Available at <http://www.jstor.org.libproxy.mit.edu/stable/2296233>.
- LiveMint (2017). Solar power tariff falls to record low of Rs3.15 a unit. Available at <http://www.livemint.com/Industry/VGSYBOuDh0z5NfyJuVE8xJ/Solar-power-tariff-falls-to-record-low-of-Rs315-a-unit.html>.
- Mathiesen, L (1985). Computation of economic equilibria by a sequence of linear complementarity problems. *Mathematical Programming Study*, 23, 144–162.
- Mayer, K, SG Banerjee and C Trimble (2015). *Elite Capture: Residential Tariff Subsidies in India*, Washington, DC: The World Bank. Available at <https://openknowledge.worldbank.org/handle/10986/20538>.
- McFarland, JR, JM Reilly and HJ Herzog (2004). Representing energy technologies in top-down economic models using bottom-up information. *Energy Economics*, 26(4), 685–707.
- Metcalf, GE and D Weisbach (2009). The design of a carbon tax. *Harvard Environmental Law Review*, 33(2), 499–556. Available at <http://www.heinonline.org/HOL/Page?handle=hein.journals/helr33&id=503&collection=journals&index=journals/helr>.
- Morris, JF *et al.* (2014). Advanced technologies in energy-economy models for climate change assessment. *Joint Program Report Series Report 272 (272)*, p. 24. Available at https://globalchange.mit.edu/sites/default/files/MITJPSPGC_Rpt272.pdf.

- Morris, JF, JM Reilly and S Paltsev (2010). Combining a renewable portfolio standard with a cap-and-trade policy: A general equilibrium analysis. *Joint Program Report Series Report 187* (187), p. 19. Available at <https://globalchange.mit.edu/publication/13783>.
- Murphy, DD (2002). The business dynamics of global regulatory competition. In *Dynamics of Regulatory Change: How Globalization Affects National Regulatory Policies*, R Kagan and D Vogel (eds.) Berkeley: University of California Press.
- NITI Aayog (2015). Report of the expert group on 175 GW RE by 2022, National Institute for Transforming India. Available at http://niti.gov.in/writereaddata/files/writereaddata/files/document_publication/report-175-GW-RE.pdf.
- OECD (2017). GDP long-term forecast. Available at <https://data.oecd.org/gdp/gdp-long-term-forecast.htm#indicator-chart>.
- Ojha, VP (2009). Carbon emissions reduction strategies and poverty alleviation in India. *Environment and Development Economics*, 14(3), 323–348. Available at: <http://dx.doi.org/10.1017/S1355770X0800497X>.
- Olson, M (1984). *The Rise and Decline of Nations: Economic Growth, Stagflation, and Social Rigidities*, London; New Haven, CT: Yale University Press.
- Peters, JC (2016). The GTAP-Power Data Base: Disaggregating the electricity sector in the GTAP data base. *Journal of Global Economic Analysis*, 1(1), 209–250.
- Poterba, JM (1991). Tax policy to combat global warming: On designing a carbon tax. *NBER Working Paper Series* (March).
- Rausch, S and VJ Karplus (2014). Markets versus regulation: The efficiency and distributional impacts of U.S. climate policy proposals. *Energy Journal*, 35(SPEC. ISSUE 1), 199–227.
- Rutherford, TF (1995). Extension of GAMS for complementarity problems arising in applied economic analysis. *Journal of Economic Dynamics and Control*, 19(8), 1299–1324.
- Rutherford, TF (1998). Economic equilibrium modeling with GAMS: An introduction to GAMS/MCP and GAMS/MPSGE (June). Available at <http://www.gams.com/dd/docs/tools/mpsge.pdf>.
- Rutherford, T (2002). Lecture notes on constant elasticity functions. *University of Colorado*. Available at <http://www.gamsworld.eu/mpsge/debreu/ces.pdf>.
- Shukla, PR, S Dhar and D Mahapatra (2008). Low-carbon society scenarios for India. *Climate Policy*, 8:Sup1(June). Available at: <http://dx.doi.org/10.3763/cpol.2007.0498>.
- Stavins, RN (2008). Addressing climate change with a comprehensive US cap-and-trade system. *Oxford Review of Economic Policy*, 24(2), 298–321.
- Stigler, GJ (1971). The theory of economic regulation. *The Bell Journal of Economics and Management Science*, 2(1), 3–21.
- Thapar, S, S Sharma and A Verma (2018). Energy for sustainable development analyzing solar auctions in India: Identifying key determinants. *Energy for Sustainable Development*, 45(November 2014), 66–78. Available at <https://doi.org/10.1016/j.esd.2018.05.003>.
- Thompson, TM *et al.* (2014). A systems approach to evaluating the air quality co-benefits of US carbon policies. *Nature Climate Change* (August).
- Tongia, R (2016). *India's Updated (2016) Renewable Energy "Guidelines": Bold Targets, but can we Meet Them?* Available at https://www.brookings.edu/wp-content/uploads/2016/09/201608_rposforindia_rt-2-11.pdf.
- Tongia, R and S Gross (2019). *Coal in India Adjusting to Transition*, Washington, DC. Available at <https://www.brookings.edu/blog/planetpolicy/2019/03/08/coal-is-king-in-india-and-will-likely-remain-so/>.
- U.S. EIA (2017). *Annual Energy Outlook 2017*. Available at [http://www.eia.gov/outlooks/aeo/pdf/0383\(2017\).pdf](http://www.eia.gov/outlooks/aeo/pdf/0383(2017).pdf).

- Weitzman, ML (1974). Prices vs. quantities. *Review of Economic Studies*, 41(January), 477–491. Available at <http://ideas.repec.org/a/bla/restud/v41y1974i4p477-91.html>.
- Winchester, N and JM Reilly (2015). The feasibility, costs, and environmental implications of large-scale biomass energy. *Energy Economics*, 51, 188–203. Available at <http://dx.doi.org/10.1016/j.eneco.2015.06.016>.
- World Bank (2014a). CO2 emissions (kg per 2011 PPP \$ of GDP) | Data. Available at <https://data.worldbank.org/indicator/EN.ATM.CO2E.PP.GD.KD?locations=IN> [accessed 20 September 2017].
- World Bank (2014b). Electric power consumption (kWh per capita). Available at <https://data.worldbank.org/indicator/EG.USE.ELEC.KH.PC>.
- World Bank (2015). GDP growth (annual %). Available at <http://data.worldbank.org/indicator/NY.GDP.MKTP.KD.ZG?locations=IN>.
- World Bank (2016). *South Asia Economic Focus: Investment Reality Check*, Available at <https://openknowledge.worldbank.org/handle/10986/25096>.
- World Bank (2017). *India — Country Snapshot*, Washington, DC. Available at <http://documents.worldbank.org/curated/en/488791507885476136/India-Country-snapshot>.
- World Bank (2019). *Global economic prospects*, 18. Available at <http://www.worldbank.org/en/publication/global-economic-prospects>.